

SE - APB1 Serie - Aufputz Alugehäuse, Schutzart IP 55 (wassergeschützt), I th 16A

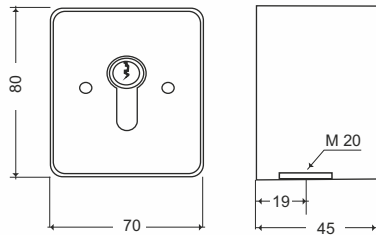

Art. Nr.	TYP	FUNCTION	SYMBOL	PREIS €
130001	SE-APB1-1T	1seitiger Tast (one way momentary impuls 1 côté)		
130002	SE-APB1-2T	2seitiger Tast (two way momentary impuls 2 côtés)		

SE - UPB1 Serie - Unterputz Alugehäuse, Schutzart IP 55 (wassergeschützt), I th 16A

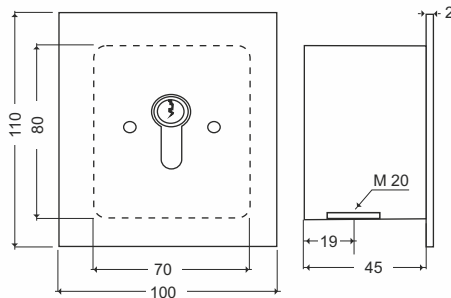

Art. Nr.	TYP	FUNCTION	SYMBOL	PREIS €
130010	SE-UPB1-1T	1seitiger Tast (one way momentary impuls 1 côté)		
130011	SE-UPB1-2T	2seitiger Tast (two way momentary impuls 2 côtés)		

SE - UPR1 Serie - Unterputz Alugehäuse, Schutzart IP 55 (wassergeschützt), I th 16A

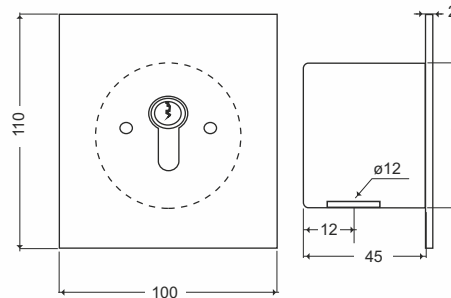

Art. Nr.	TYP	FUNCTION	SYMBOL	PREIS €
140001	SE-UPR1-1T	1seitiger Tast (one way momentary impuls 1 côté)		
140002	SE-UPR1-2T	2seitiger Tast (two way momentary impuls 2 côtés)		

SE - UPRA1 Serie - Unterputz Alugehäuse, Schutzart IP 55 (wassergeschützt), I th 16A

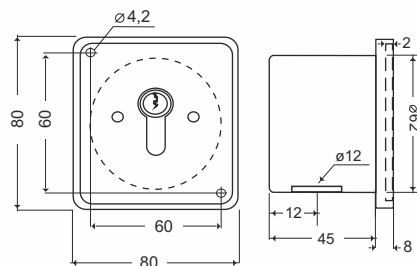

Art. Nr.	TYP	FUNCTION	SYMBOL	PREIS €
150001	SE-UPRA1-1T	1seitiger Tast (one way momentary impuls 1 côté)		
150002	SE-UPRA1-2T	2seitiger Tast (two way momentary impuls 2 côtés)		

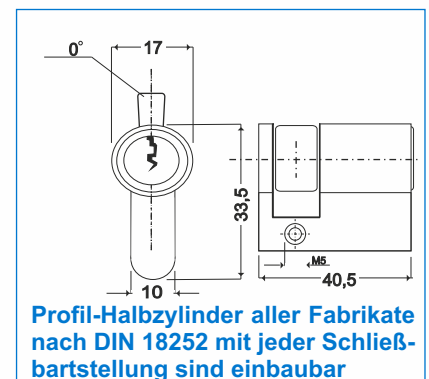
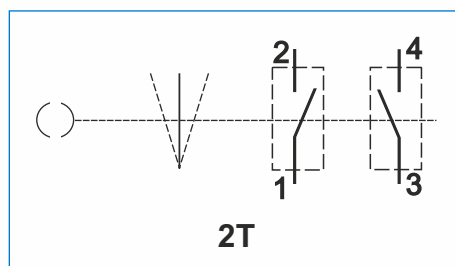
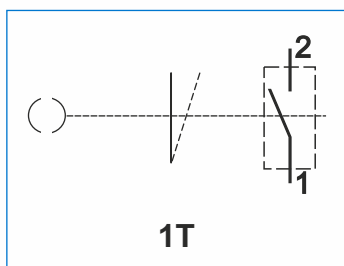

Technische Daten SE-APB1, SE-UPB1, SE-UPR1, SE-UPRA1 Serie : Schutzart IP 55, I th 16A, AC 3
Schalter entsprechen den EN 60947-5-1 Norm (1 oder 2 seitigem Tastkontakt)